

Inquisitive Semantics and Pragmatics

Jeroen Groenendijk

Seminar NYU Linguistics Spring 2009
www.illc.uva.nl/inquisitive-semantics

Lecture 2, January 28



31

The Gricean Picture of Disjunction

In 'Indicative Conditionals', Grice (1989:68), as cited in Simons (2000)

A standard (if not the standard) employment of "or" is in the specification of possibilities (one of which is supposed by the speaker to be realized, although he does not know which one), each of which is relevant in the same way to a given topic.

- The Gricean Picture of Disjunction is a picture of its use
- Inquisitive Semantics turns it into a picture of the meaning of disjunction

32

Two Possibilities for Disjunction

(1) Alf will go to the party, or Bea will go

- ◁ It is part of the meaning of (1) that it draws attention to two distinct possibilities: the possibility that Alf will go, and the possibility that Bea will go
- ◁ It depends on intonation, and on the way in which the disjunction is phrased, whether or to what extent, this effect occurs
- ◁ Also in this sense: two possibilities for disjunction

33

Possibilities and Inquisitiveness

- ◁ If a sentence draws attention to a certain possibility, we say that it is a possibility for that sentence
- ◁ If there is more than one possibility for a sentence we say that the sentence is an inquisitive sentence
- ◁ The disjunction in (1) is (can be) inquisitive
- ◁ Or: (1) is ambiguous between an inquisitive and a non-inquisitive reading

34

Evidence for Possibilities

- ◁ What evidence is there that drawing attention to possibilities is part of meaning, rather than just a pragmatic effect?
- ◁ Present set of examples: observations of (non-) redundancy facts, which are structurally like (non-) entailment facts
- ◁ Other sets of examples concern observations about the compliance of a response to an initiative

35

Redundancy Observation

(1) Alf will go to the party, or Bea will go

(2) Will Alf or Bea go to the party?

- ◁ A continuation of (1) with (2), when read as an alternative question, sounds redundant
- ◁ Each of the two possibilities for (1) is a possibility for (2) as well
- ◁ Has the features of an entailment fact, meaning-inclusion, if possibilities are part of meaning

36

Non-Redundancy Observation

- (1) Alf will go to the party, or Bea will go
- (2) Will Alf or Bea go to the party?
- (3) Will Alf go to the party?
 - A continuation of (1) or (2) with the yes/no-question in (3), sounds not equally redundant
 - Only one of the two possibilities for (3), the positive answer, is shared by (1) and (2)

37

Non-Redundancy Observation (cont.)

- (1) Alf will go to the party, or Bea will go
- (2) Will Alf or Bea go to the party?
- (3) Will Alf go to the party?
 - Still, also the negative answer to (3) has the net effect of an answer to (2)
 - The discourse relation between (1) and (2) is different from that between (1) and (3)
 - Must come from the meaning of (1)

38

Equivalence?

- (1) Alf will go to the party, or Bea will go
- (4) It is not the case that neither Alf nor Bea will go to the party
- (5) If Alf does not go to the party, Bea will go
 - The disjunction in (1), like (4) and (5), excludes the possibility that neither Alf nor Bea goes
 - (1), (4) and (5) are classically equivalent, are informatively equivalent

39

Redundancy/Non-Redundancy Contrast

- (1) Alf will go to the party, or Bea will go
- (2) Will Alf or Bea go to the party?
 - Whereas continuation of (1) with (2) does, a continuation of (4) with (2) does not sound redundant
- (4) It is not the case that neither Alf nor Bea will go to the party
- (2) Will Alf or Bea go to the party?
 - The possibilities for (2) are not there for (4)

40

First Aim of Inquisitive Semantics

- Design a 'minimal' semantics where the possibilities a sentence draws attention to form its meaning
- The proposition expressed by a sentence is not just its informative content (classical proposition), but determines the possibilities for a sentence (set of classical propositions)
- We'll provide an inquisitive semantics for a logical language of propositional logic

41

Logical Query language

- Standardly, you build a query language QL on the basis of a purely indicative language L, and add questions on top of that:
 - If $\varphi \in L$, then $\varphi \in QL$ and $?\varphi \in QL$
- In the language QL there are two distinct syntactic categories, their meanings are of different semantic types:
 - propositions: set of worlds;
 - questions: partition of the set of worlds

42

Proposition - Question

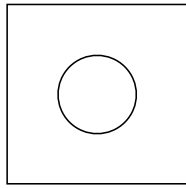

single possibility

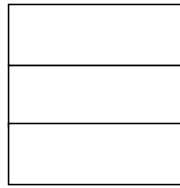

set of (mutually exclusive) possibilities

43

Hybrid Logical Language

- ⦿ In a hybrid logical language there is a single syntactic category of sentences
- ⦿ Questions and assertions are different semantic categories of sentences
- ⦿ Semantic categories are defined in terms of semantic properties:
 - ▢ Questions are not informative
 - ▢ Assertions are not inquisitive

44

Hybrid Logical Language (cont.)

- ⦿ Inquisitiveness and informativeness do not exclude each other
- ⦿ There will be hybrid sentences in the language which are both informative and inquisitive, and hence are neither questions nor assertions
 - ▢ Simple disjunctions will count as hybrid sentences

45

90° Semantics Paradigm Shift

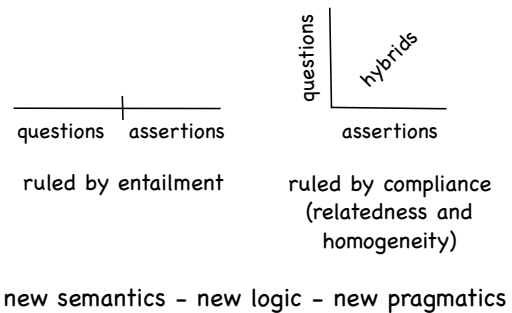

46

Remark on Hybridity

- ⦿ Using a hybrid logical language is not a matter of principle
- ⦿ It does not embody any sort of claim about hybridity or not of natural language
- ⦿ It's just a matter of fact that such a simple logical language suffices to reach our aim:
 - ▢ To turn the Gricean picture of the use of disjunction into a picture of its meaning

47



Hybrid Propositional Syntax

PV set of propositional variables

1. If $p \in PV$, dan $p \in L$
 2. $\perp \in L$
 3. If $\varphi \in L$ and $\psi \in L$, then $(\varphi \rightarrow \psi) \in L$
 4. If $\varphi \in L$ and $\psi \in L$, then $(\varphi \wedge \psi) \in L$
 5. If $\varphi \in L$ and $\psi \in L$, then $(\varphi \vee \psi) \in L$
- gives classical logic
- gives Inquisitiveness

48

Notation Conventions

- Two standard additions to the language:
 1. negation $\neg\varphi =_{\text{def}} (\varphi \rightarrow \perp)$
 2. tautology $\top =_{\text{def}} \neg\perp$
- Two non-standard additions to the language in which its hybrid nature surfaces:
 1. assertions $!\varphi =_{\text{def}} \neg\neg\varphi$
 2. questions $?\varphi =_{\text{def}} (\varphi \vee \neg\varphi)$

49

Some Examples of Sentences

- Syntax allows for things like
 - $(p \vee q), !(p \vee q), ?(p \vee q)$
 - $(p \rightarrow ?q), (?p \vee ?q), (?p \wedge ?q), (p \wedge ?q)$
 - $\neg?p, !?p, !!p, ??p, (?p \rightarrow q), (?p \rightarrow ?q)$

50

Ingredients of the Semantics

- Basic ingredients of the semantics for a language L with atomic sentences P are the suitable indices for L (aka possible worlds)
- Such suitable indices are all valuations v such that for every $p \in P: v(p) = 1$ or 0
- We also define the notion of a possibility as a non-empty set of indices
- We use i, j, k , as variables ranging over possibilities. So, $i \subseteq j$ implies $i \neq \emptyset$

51

Structure of the Semantics

- The basic component of the semantics is the recursive statement of a satisfaction relation for the sentences of the language
 - Like classically: $v \models \varphi$
- In terms of that we define the proposition expressed by a sentence φ
 - Like classically: $\{v \mid v \models \varphi\}$

52

Versions of Inquisitive Semantics

- There are different versions of the semantics
 - Denotational versions: $x \models \varphi$
 1. Inquisitive pair-semantics: $\langle v, u \rangle \models \varphi$
 2. General inquisitive semantics: $i \models \varphi$
 - Update version $s[\varphi]$, where s is a set of pairs, and $s[\varphi] = \{\langle v, u \rangle \in s \mid \langle v, u \rangle \models \varphi\}$

53

Historical Note on Versions

- First update version, following the lead of The Logic of Interrogation
 - Only, states just reflexive and symmetric relations on a subset of the set of indices, dropping transitivity, i.e., leaving equivalence relations, dumping partitions
- Second, the denotational pair-version, fully equivalent with the update version
- Finally, the stronger general version



54

Back to the Structure of the Semantics

- Basic component satisfaction relation
 $\langle v, u \rangle \models \varphi$ or $i \models \varphi$
- In terms of that we define the proposition expressed by a sentence φ as the set of (alternative) possibilities for φ .
- In both cases: proposition is a set of possibilities, but obtained in a different way from the two different satisfaction relations, and sometimes leading to different results

55

Some Pictures of Meanings

all questions

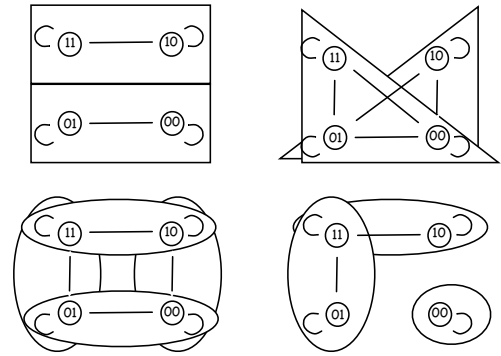

56

Inquisitive Pair-Semantics

1. $\langle v, u \rangle \models p$ iff $v(p) = 1$ and $u(p) = 1$
2. $\langle v, u \rangle \not\models \perp$
3. $\langle v, u \rangle \models (\varphi \wedge \psi)$ iff $\langle v, u \rangle \models \varphi$ and $\langle v, u \rangle \models \psi$
4. $\langle v, u \rangle \models (\varphi \vee \psi)$ iff $\langle v, u \rangle \models \varphi$ or $\langle i, j \rangle \models \psi$
5. $\langle v, u \rangle \models (\varphi \rightarrow \psi)$ iff for all $\pi \in \{v, u\}^2$:
 if $\pi \models \varphi$, then $\pi \models \psi$

57

General Inquisitive Semantics

1. $i \models p$ iff for all $v \in i$ $v(p) = 1$
2. $i \not\models \perp$
3. $i \models (\varphi \wedge \psi)$ iff $i \models \varphi$ and $i \models \psi$
4. $i \models (\varphi \vee \psi)$ iff $i \models \varphi$ or $i \models \psi$
5. $i \models (\varphi \rightarrow \psi)$ iff for all $j \subseteq i$
 if $j \models \varphi$, then $j \models \psi$

58

Two Theorems for the two Semantics

- ☑ Symmetry and Reflexive Closure:
 If $\langle v, u \rangle \models \varphi$, then $\langle u, v \rangle \models \varphi$ and $\langle v, v \rangle \models \varphi$
 and $\langle u, u \rangle \models \varphi$
- ☑ Persistence
 If $i \models \varphi$, then for all $j \subseteq i$: $j \models \varphi$
- These parallel properties of the satisfaction relations enable the following parallel notions of propositions:

59

Propositions in the two semantics

- In both semantics: The proposition expressed by φ is the set of possibilities for φ
- ☐ Possibility for φ in the pair-semantics:
 a \subseteq -maximal possibility i such that for all
 $v, u \in i$: $\langle v, u \rangle \models \varphi$
- ☐ Possibility for φ in the general semantics:
 a \subseteq -maximal possibility i such that $i \models \varphi$

60

Entailment and Possibilities

- ⦿ The notion of entailment and validity is standard in both semantics, in the general version:
 - ⊖ $\varphi \models \psi$ iff for all i : if $i \models \varphi$, then $i \models \psi$
 - ⊖ $i \models \varphi$ iff for all i : $i \models \varphi$
- ⦿ In terms of possibilities, for both versions:
 - ⊖ $\varphi \models \psi$ iff every possibility for φ is included in some possibility for ψ

61

Entailment and Redundancy Facts

- ⦿ The notion of meaning inclusion needed to account for the (non) redundancy observations we discussed at the start is stronger than the notion of entailment:
 - ⊖ $\varphi \models \psi$ iff every possibility for φ is included in a possibility for ψ
 - ⊖ ψ is redundant after φ iff every possibility for φ is a possibility for ψ

62

Entailment and the Logic of Conversation

- ⦿ The notion of entailment is not the logical notion that accounts for discourse coherence, for the compliance of a response to an initiative
- ⦿ compliance is central to inquisitive semantics
- ⦿ The notion of compliance combines the notions of relatedness and homogeneity, to be discussed in the next meeting

63

Properties of propositions

- ⦿ A sentence φ is consistent iff there is a possibility for φ
- ⦿ A sentence φ is inquisitive iff there is more than one possibility for φ
- ⦿ A sentence φ is informative iff the union of the possibilities for φ does not equal the set of all indices
- ⦿ A sentence φ is meaningful iff φ is consistent, and φ is inquisitive or informative

64

Properties in terms of pair-satisfaction

1. φ is consistent iff for some $\langle v, u \rangle$: $\langle v, u \rangle \models \varphi$
 2. φ is informative iff for some v : $\langle v, v \rangle \not\models \varphi$
 3. φ is inquisitive iff for some v and u : $\langle v, v \rangle \models \varphi$ and $\langle u, u \rangle \models \varphi$, but $\langle v, u \rangle \not\models \varphi$
 4. φ is meaningful iff for some $\langle v, u \rangle$: $\langle v, u \rangle \models \varphi$ and for some $\langle v, u \rangle$: $\langle v, u \rangle \not\models \varphi$
- ⦿ If $\{v \mid \langle v, v \rangle \not\models \varphi\} \neq \emptyset$, we refer to it as the possibility excluded by φ , else we say φ excludes no possibility

65

Properties in terms of gen-satisfaction

1. φ is consistent iff for some i : $i \models \varphi$
2. φ is informative iff for some v : $\{v\} \not\models \varphi$
3. φ is inquisitive iff for some i and j : $i \models \varphi$ and $j \models \varphi$, but $i \cup j \not\models \varphi$
4. φ is meaningful iff for some i : $i \models \varphi$ and for some i : $i \not\models \varphi$

66

Pair Non-Inquisitive = Classical

- ⊙ φ is inquisitive iff for some v and u :
 $\langle v, v \rangle \models \varphi$ and $\langle u, u \rangle \models \varphi$, but $\langle v, u \rangle \not\models \varphi$
 - ⊙ φ is not inquisitive iff for all v and u : if
 $\langle v, v \rangle \models \varphi$ and $\langle u, u \rangle \models \varphi$, then $\langle v, u \rangle \models \varphi$
- By the Symmetry and Reflexive closure Theorem
- ⊙ φ is not inquisitive iff
 $\langle v, u \rangle \models \varphi$ iff $\langle v, v \rangle \models \varphi$ and $\langle u, u \rangle \models \varphi$

67

Gen-Non-Inquisitive = Classical

- ⊙ φ is inquisitive iff for some i and j :
 $i \models \varphi$ and $j \models \varphi$, but $i \cup j \not\models \varphi$
 - ⊙ φ is not inquisitive iff for all i and j : if
 $i \models \varphi$ and $j \models \varphi$, then $i \cup j \models \varphi$
- By the Persistence Theorem
- ⊙ φ is not inquisitive iff
 $i \models \varphi$ iff for all $v \in i$: $v \models \varphi$

68

Five Semantic classes of sentences

1. φ is a contradiction iff φ is not consistent (meaningless assertion)
2. φ is a tautology iff φ is not inquisitive and not informative (meaningless question and meaningless assertion)
3. φ is an assertion iff φ is not inquisitive
4. φ is a question iff φ is not informative
5. φ is a hybrid iff φ is inquisitive and informative (neither question nor assertion)

69

Five mutually exclusive classes, exhausting the logical space

	cons	inf	inq	poss	excl
contradiction	-	+	-	0	1
tautology	+	-	-	1	0
meaningful assertion	+	+	-	1	1
meaningful question	+	-	+	≥ 2	0
hybrid	+	+	+	≥ 2	1

70

Disjunction Free Fragment of L is classical

1. $\langle v, u \rangle \models p$ iff $v(p) = 1$ and $u(p) = 1$
- ⊙ Atomic sentences are assertions
 - 2. $\langle v, u \rangle \not\models \perp$
 - ⊙ The contradiction is an assertion
 - 3. $\langle v, u \rangle \models (\varphi \wedge \psi)$ iff $\langle v, u \rangle \models \varphi$ and $\langle v, u \rangle \models \psi$
 - ⊙ If φ and ψ are assertions, then $(\varphi \wedge \psi)$ is
 1. $\langle v, u \rangle \models (\varphi \rightarrow \psi)$ iff for all $\pi \in \{v, u\}^2$:
 if $\pi \models \varphi$, then $\pi \models \psi$
 - ⊙ If ψ is an assertion, then $(\varphi \rightarrow \psi)$ is

71

Conditionals: Divide and Conquer

- ⊙ It is sufficient for a conditional to count as an assertion that the consequent is, no matter the nature of the antecedent:
- ⊙ If ψ is an assertion, then $(\varphi \rightarrow \psi)$ is
- ⊙ Likewise: it is sufficient for a conditional to count as a question that the consequent is, no matter the nature of the antecedent:
- ⊙ If ψ is a question, then $(\varphi \rightarrow \psi)$ is
- ⊙ It holds for any conditional that
- ⊙ $(\varphi \rightarrow \psi)$ is equivalent with $(\varphi \rightarrow !\psi) \wedge (\varphi \rightarrow ?\psi)$

72

Negation is classical

Since \perp is an assertion, and $\varphi \rightarrow \psi$ is an assertion if is, $\varphi \rightarrow \perp$ is an assertion, and hence $\neg\varphi$ is. Hence:

- $\langle v, u \rangle \models \neg\varphi$ iff $\langle v, v \rangle \not\models \varphi$ and $\langle u, u \rangle \not\models \varphi$
- $\langle v, u \rangle \models !\varphi$ iff $\langle v, v \rangle \models \varphi$ and $\langle u, u \rangle \models \varphi$
- $i \models \neg\varphi$ iff for all $v \in i: \{v\} \not\models \varphi$
- $i \models !\varphi$ iff for all $v \in i: \{v\} \models \varphi$

73

Tautology and Questions

1. $\langle v, u \rangle \models \top$
2. $\langle v, u \rangle \models ?\varphi$ iff $\langle v, u \rangle \models \varphi$ or $\langle v, v \rangle \not\models \varphi$ and $\langle u, u \rangle \not\models \varphi$

1. $i \models \top$
2. $i \models ?\varphi$ iff $i \models \varphi$ or for all $v \in i: \{v\} \not\models \varphi$

$?\varphi = \varphi \vee \neg\varphi$ is not a tautology as long as φ is meaningful

74

Assertions and Questions

- $?\varphi$ is a question, i.e., $?\varphi$ is not informative
- $!\varphi$ is an assertion, i.e., $!\varphi$ is not inquisitive
- $?\varphi$ is equivalent with φ iff φ is a question
- $!\varphi$ is equivalent with φ iff φ is an assertion
- $??\varphi$ is equivalent with $?\varphi$
- $!!\varphi$ is equivalent with $!\varphi$
- φ is a question iff $\neg\varphi$ is a contradiction

75

One Possibility for Atomic Sentence p

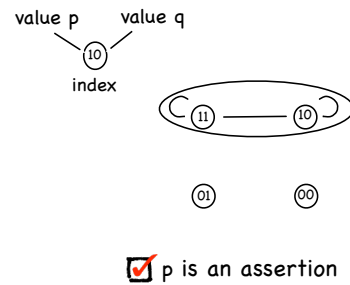

76

Two Possibilities for Disjunction ($p \vee q$)

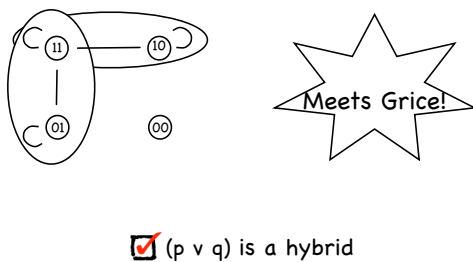

77

One Possibility for $!(p \vee q)$

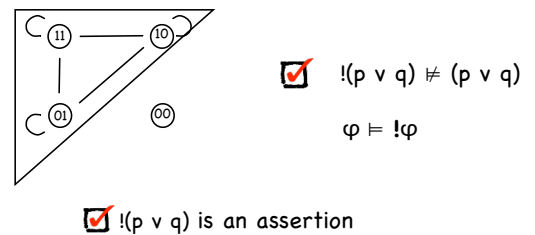

78

Two Possibilities for $?p = (p \vee \neg p)$ No Possibility Excluded

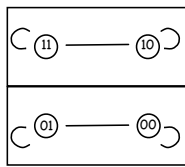

$\models (p \vee \neg p)$
 $\models \neg(p \vee \neg p)$
 $\models \neg p$
 $\neg p \models \perp$

$?p$ is a question

For all φ : $? \varphi$ is a question

79

Conditional question ($p \rightarrow ?q$)

Questioned conditional
 $?(p \rightarrow q)$

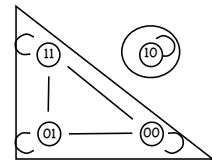
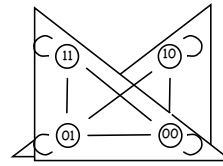

$(p \rightarrow ?q)$ is a question

$(p \rightarrow q) \models (p \rightarrow ?q)$

$?(p \rightarrow q) \models (p \rightarrow ?q)$

80

Conditional Questions

(1) If John goes, will Mary go as well? ($p \rightarrow ?q$)

Polar question, two possibilities:

(a) (Yes) If John goes, then Mary will go as well ($p \rightarrow q$)

(b) (No) If John goes, then Mary will not go ($p \rightarrow \neg q$)

Not a partition, the possibilities overlap

81

Conditionals, and disjunction

1. $\varphi \models \psi$ iff $\models (\varphi \rightarrow \psi)$

2. $\varphi \models \neg \psi$ iff $\neg \varphi \models \psi$

3. $(\varphi \rightarrow (\psi \vee \xi)) \Leftrightarrow ((\varphi \rightarrow \psi) \vee (\varphi \rightarrow \xi))$

4. $((\varphi \vee \xi) \rightarrow \psi) \Leftrightarrow ((\varphi \rightarrow \psi) \wedge (\xi \rightarrow \psi))$

82

Disjunctions of Conditionals

(1) If John goes, will Mary go as well?

(2) If John goes, Mary goes as well, or if John goes, Mary does not go

(2) Has many different intonation patterns. Most of them invite the same two responses as the conditional question (1)

$(p \rightarrow ?q)$ and $(p \rightarrow q) \vee (p \rightarrow \neg q)$ are indeed equivalent

83

Equivalent:

1. $(p \rightarrow (q \vee \neg q))$

2. $(p \rightarrow q) \vee (p \rightarrow \neg q)$

3. $(p \rightarrow ?q)$

4. $?(p \rightarrow q) \vee ?(p \rightarrow \neg q)$

5. $(p \rightarrow q) \vee ?(p \rightarrow \neg q)$

6. $(p \rightarrow ?(q \vee \neg q))$

84

Disjunctive Antecedent

- (6) If John or Mary goes, Peter goes as well
- (7) If John goes, Peter goes as well, and if Mary goes, Peter goes as well
- ☐ These are equivalent, and so are:
- (8) If John or Mary goes, will Peter go as well?
- (9) If John goes, will Peter go as well?, and if Mary goes, will Peter go as well?

85



Equivalent:

1. $((p \vee q) \rightarrow ?r)$
2. $(p \rightarrow ?r) \wedge (q \rightarrow ?r)$
3. $((p \vee q) \rightarrow r) \vee ((p \vee q) \rightarrow \neg r) \vee ((p \rightarrow r) \wedge (q \rightarrow \neg r)) \vee ((q \rightarrow r) \wedge (p \rightarrow \neg r))$

86

Question with Disjunctive Antecedent

- (8) If John or Mary goes, will Peter go as well?
- ☐ Four possibilities:
- (a) If John or Mary goes, Peter will go as well
 - (b) If John or Mary goes, Peter will not go
 - (c) If John goes, Peter will go as well, but if Mary goes Peter will not go
 - (d) If Mary goes, Peter will go as well, but if John goes Peter will not go

87

Alternative question $?(p \vee q)$ Choice question $(?p \vee ?q)$

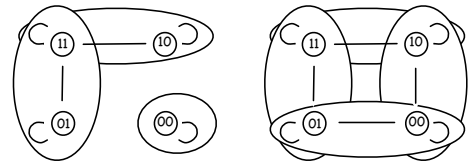

88

☐ To be continued on February 18

89